

100mmx52mm, Iron Frame
0.7in, PESVW Voice Coil, kapton Former
Paper cone, Rubber Surround
Neodymium Magnet Motor System
Spider-Less, Rectangular design

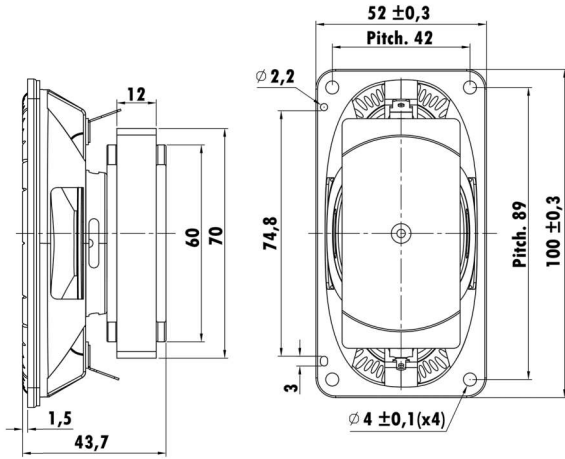

T-S Parameters

Resonance frequency [fs]	197 Hz
Mechanical Q factor [Qms]	5.0
Electrical Q factor [Qes]	3.1
Total Q factor [Qts]	1.9
Force factor [Bl]	2.5 Tm
Mechanical resistance [Rms]	0.7 kg/s
Moving mass [Mms]	3 g
Compliance [Cms]	0.2 mm/N
Effective diaph. diameter [D]	64.9 mm
Effective piston area [Sd]	33.1 cm ²
Equivalent volume [Vas]	0.31 l
Sensitivity (2.83V/1m)	81 dB
Ratio Bl/√Re	1.11 N/√W
Ratio fs/Qts	101.2 Hz

Electrical Data

Nominal impedance [Zn]	6 Ω
Minimum impedance [Zmin]	5.9 Ω
Maximum impedance [Zo]	15 Ω
DC resistance [Re]	5.3 Ω
Voice coil inductance [Le]	1.34 mH

Power Handling

100h RMS noise test (IEC 18.4)	15 W
Long-term max power (IEC 18.2)	- W

Voice Coil & Magnet Data

Voice coil diameter	18.4 mm
Voice coil height	7.0 mm
Voice coil layers	2
Height of gap	3 mm
Linear excursion	± 2 mm
Max mech. excursion	± - mm
Unit weight	250 kg

